



Puertas & Portones Automáticos, S.A. de C.V.  
*¡Nuestra pasión es la Solución!....*

## » TRANSMISOR TIPO LLAVERO MX4CH WOLF ELECTRONICS MOD.INSTALLER VERDE



# MANUAL DE INSTALACION

CÓDIGO	SKU	MODELO	DESCRIPCION
MF-00003-00	DS-055	TX-INSTALLER	TRANSMISOR T/LLAV T/MX4CH INSTALLER VERDE

VERSIÓN 1  
FEBRERO 2019



(229) 288-1552

portonesautomaticos@adsver.com.mx  
portonesautomaticos@prodigy.net.mx



(229) 927-5107, 167-8080, 167-8007, 151-7529.

www.adsver.com.mx

*Las frecuencias por debajo de 433 MHz están prohibidas en Europa. Solo se permiten en países donde están autorizadas y que no pertenecen a la UE. Cualquier uso o manejo de estas frecuencias es responsabilidad del comprador.*

En cumplimiento de la DIRECTIVA 2014/53/EU

FABRICADO POR /FAB: ESB06450563

## MANUAL TX NEW CLONER

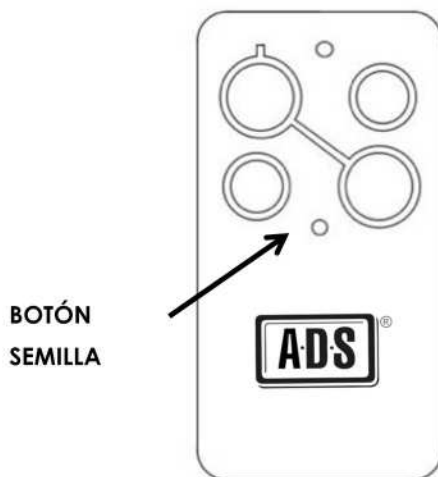

**BOTÓN  
SEMILLA**

### CARACTERÍSTICAS TÉCNICAS

- ✓ Modelo TX NEW CLONER
- ✓ 1 Batería 2032(3V)
- ✓ Frecuencia de 433,92 a 900 Mhz
- ✓ 4 Canales
- ✓ Chip especial
- ✓ Software patentado New Cloner

**ATENCIÓN, ESTE MANDO TIENE DOS MODOS DE TRABAJO:**

1. ENTRADA DIRECTA EN EL RECEPTOR
2. CLON

**ATENCIÓN: EN EL TX NEWCLONER (MULTICLONER) SE PUEDE PONER UNA MARCA Y UNA FRECUENCIA DIFERENTE EN CADA BOTÓN (CANAL) SOLO EN MODO CLON.**

## MODO DE ENTRADA DIRECTA EN EL RECEPTOR

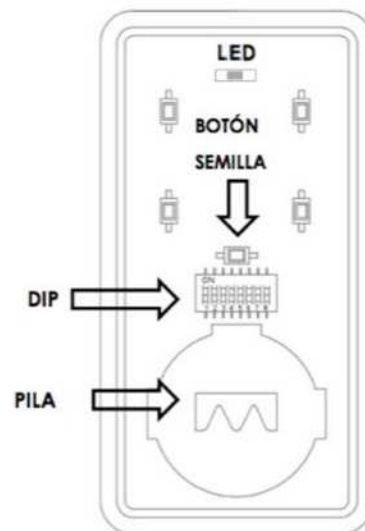
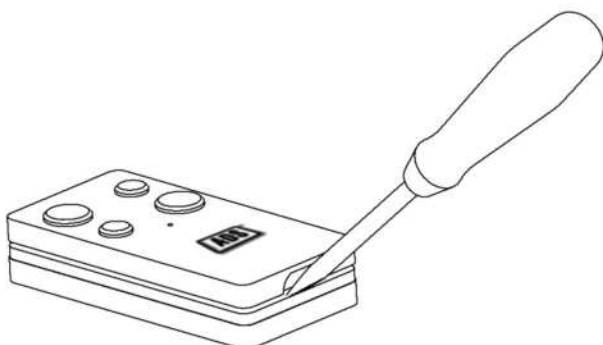

### INSTRUCCIONES DE PROGRAMACIÓN

1. Localizar el selector DIP en el interior del mando. Hacer palanca para separar la carcasa mediante la pestaña de la cara inferior según la imagen de abajo.
2. Seleccionar la combinación en el DIP para la marca elegida. Ir a la tabla 1.
3. El mando está listo para ser usado. Consultar el manual de usuario del receptor.



**Nota:** Para BFT, MUTANCODE y ERREKA es necesario presionar el botón oculto (con un clip u objeto pequeño) antes de pulsar un botón (botones del 1 al 4).

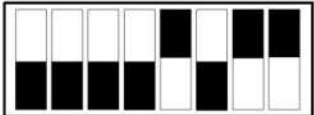
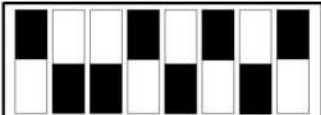
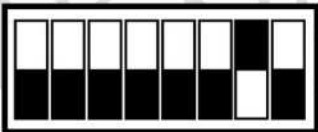

Tabla 1: Entrar directamente en el receptor.

Num	DIP SWITCHES	R/F	Brand Marca	Original	Comments Comentarios
1	<p>1 2 3 4 5 6 7 8</p> 	Rolling Code	Compatible con <b>APRIMATIC</b> TR 433.92 MHZ		
2	<p>1 2 3 4 5 6 7 8</p> 	Fixed Code	Compatible con <b>APRIMATIC</b> TR 433.92 MHZ		
3	<p>1 2 3 4 5 6 7 8</p> 	Rolling Code	Compatible con <b>BENINCA</b> TO GO WV / WP T WV / WK CUPIDO 433.92 MHZ		
4	<p>1 2 3 4 5 6 7 8</p> 	Rolling Code	Compatible con <b>BFT MITTO</b> 433.92 MHZ		Hidden button Botón semilla
5	<p>1 2 3 4 5 6 7 8</p> 	Rolling Code	Compatible con/with <b>CARDIN</b> S449-QZ2 433.92 MHZ		

# MANUAL DE INSTALACION



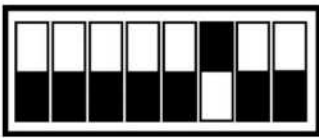
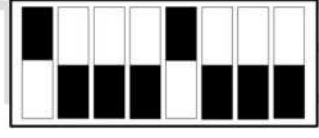



6	<p>1 2 3 4 5 6 7 8</p> 	Rolling Code	<p><b>Compatible con/with CENTURION 433.92 MHZ</b></p>		
7	<p>1 2 3 4 5 6 7 8</p> 	Rolling Code	<p><b>Compatible con/with DEA (KING SISTEM) GENIE GENIE GREEN GENIE WOOD MIO TR-2 433.92 MHZ</b></p>		
8	<p>1 2 3 4 5 6 7 8</p> 	Fixed Code	<p><b>Compatible con/with DITEC GOL4 GOL4C BIXLP2 433.92 MHZ</b></p>		
9	<p>1 2 3 4 5 6 7 8</p> 	Rolling Code	<p><b>Compatible con/with DOORHAN 433.92 MHZ</b></p>		
10	<p>1 2 3 4 5 6 7 8</p> 	Rolling Code	<p><b>Compatible con/with EMFA 433.92 MHZ</b></p>		

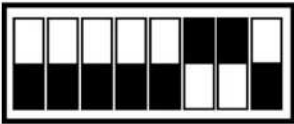

11	<p>1 2 3 4 5 6 7 8</p> 	Rolling Code	<p><b>Compatible con</b>  <b>ERREKA</b>          SOL R          SOL4R  <b>433.92 MHZ</b></p>		Hidden button Botónsemilla
12	<p>1 2 3 4 5 6 7 8</p> 	Rolling Code	<p><b>Compatible con/with</b>  <b>FAAC</b>          XT 433 RC  <b>433.92 MHZ</b></p>		Red LED LED rojo
13	<p>1 2 3 4 5 6 7 8</p> 	Rolling Code	<p><b>Compatible con/with</b>  <b>GIBIDI</b>          DOMINO          AU1600  <b>433.92 MHZ</b></p>		
14	<p>1 2 3 4 5 6 7 8</p> 	Fixed Code	<p><b>Compatible con/with</b>  <b>KEY</b>          TXB-42  <b>433.92 MHZ</b></p>		
15	<p>1 2 3 4 5 6 7 8</p> 	Fixed Code	<p><b>Compatible con/with</b>  <b>KINGATE</b>          STYLO4          MYO4 C  <b>433.92 MHZ</b></p>		
16	<p>1 2 3 4 5 6 7 8</p> 	Encrypte d Code	<p><b>Compatible con/with</b>  <b>LIFTMASTER</b>          BILLIONCODE  <b>433.92MHZ</b></p>		
17	<p>1 2 3 4 5 6 7 8</p> 	Encrypte d Code	<p><b>Compatible con/with</b>  <b>Liftmaster Chamberlain</b>  <b>Lobas</b>  <b>433.92 MHZ</b></p>		

# MANUAL DE INSTALACION

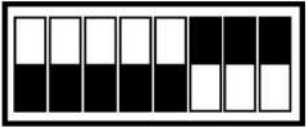
18		Encrypte d Code	<p>Compatible con/with  <b>Liftmaster</b>  <b>Chamberlain</b>  <b>Motorlift 700</b>  <b>Lobas</b>  <b>Raynor Orion</b>  <b>433.92 MHZ</b></p>		
19		Fixed Code	<p>Compatible con/with  <b>Marantec</b>  <b>Twobi</b>  <b>Raynor</b>  <b>New England</b>  <b>433.92 mhz</b></p>		
20		Rolling Code	<p>Compatible con/with  <b>MCT-3 Linear</b>  <b>433 MHZ</b></p>		
21		Fixed Code	<p>Compatible con/with  <b>MOTOR LINE</b>  <b>433.92 MHZ</b></p>		
22		Rolling Code	<p>Compatible con/with  <b>MUTAN CODE</b>  <b>433.92 MHZ</b></p>		Hidden button Botón semilla
23		Encrypte dCode	<p>Compatible con/with  <b>NICE FLOR-S</b>  <b>433.92 MHZ</b></p>		
24		Rolling Code	<p>Compatible con/with  <b>NICESMILO</b>  <b>433.92 MHZ</b></p>		

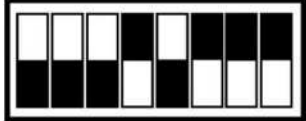
<p>25</p>	<p>1 2 3 4 5 6 7 8</p> 	<p>Rolling Code</p>	<p>Compatible con/with  <b>NOVOTROM</b>  <b>NOVOFERM</b>  <b>TORMATIC</b>  <b>433.92 MHZ</b></p>		
<p>26</p>	<p>1 2 3 4 5 6 7 8</p> 	<p>Fixed Code</p>	<p>Compatible con/with  <b>PRATEL</b>          MPSTF E          MPSTP E          TRQ P          TC E  <b>433.92 MHZ</b></p>		
<p>27</p>	<p>1 2 3 4 5 6 7 8</p> 	<p>Fixed Code</p>	<p>Compatible con/with  <b>PROTECO</b>          PTX433405          TX3  <b>433.92 MHZ</b></p>		
<p>28</p>	<p>1 2 3 4 5 6 7 8</p> 	<p>Rolling Code</p>	<p>Compatible con/with <b>PUJOL</b>          VARIO 1 OCEAN  <b>433.92 MHZ</b></p>		<p>Hidden button          Botón semilla</p>
<p>29</p>	<p>1 2 3 4 5 6 7 8</p> 	<p>Fixed Code</p>	<p>Compatible con/with <b>AVANTI</b>  <b>433.92 MHZ</b></p>		

30	<p>1 2 3 4 5 6 7 8 1 2 3 4 5 6 7 8</p>	OPEN CODE	Compatible con/with ROLLTORE 433.92 MHZ		
31	<p>1 2 3 4 5 6 7 8</p>		Compatible con/with SOMFY 433 Mhz		
32	<p>1 2 3 4 5 6 7 8</p>	Rolling Code	Compatible con/with SOMMER 434.4 Mhz		
33	<p>1 2 3 4 5 6 7 8</p>	Rolling Code	Compatible con/with SOMMER 868.8 Mhz		
34	<p>1 2 3 4 5 6 7 8</p>	Fixed Code	Compatible con/with TELCOMA TANGO 433.92 Mhz		
37	<p>1 2 3 4 5 6 7 8</p>		Compatible con/with MEDVA		
38			GENIUS 433 Mhz		



## MODO CLON

### INSTRUCCIONES DE PROGRAMACIÓN

1. Localice el selector DIP en la parte frontal del mando **CLONER (TX NEWCLONER)**. Usar un destornillador para retirar la tapa frontal. Ver página 1.
2. Seleccione la posición de los DIP para la marca deseada. Ejemplo: Código fijo. LA combinación de DIPs para código fijo se muestra en la imagen inferior.

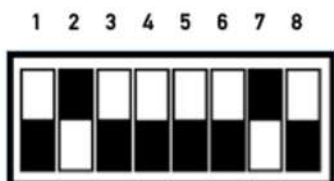

3. Pulse el botón 5 (botón oculto/semilla) del **CLONER (TX NEW CLONER)** localizado en el agujero que se encuentra debajo de los botones visibles. Esto activa el modo clon y se encenderá el LED del mando.
4. Presione UNA VEZ y SUELTE el botón de nuestro mando en el que desea utilizar el mando a clonar.
5. Acercar el mando **CLONER** al mando **ORIGINAL**.
6. Mantener pulsado el mando **ORIGINAL**. Si el procedimiento se ha realizado correctamente, el LED del mando **CLONER** emitirá 3 flashes.

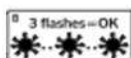





Para usar otro botón, repetir los pasos del 1 to 6.

## TX NEW CLONER

### MODO CLON / CLONE MODE

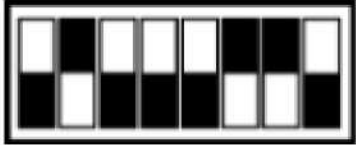
Num.	DIP SWITCHES	Brand Marca	Original	Comments Comentarios
1	<p style="text-align: center;">1 2 3 4 5 6 7 8</p>	Compatible con <b>CLEMSA</b> Mastercode.		
2	<p style="text-align: center;">1 2 3 4 5 6 7 8</p>	Compatible con <b>DITEC</b>		<b>TXD</b>
3	<p style="text-align: center;">1 2 3 4 5 6 7 8</p>	Compatible con <b>JCM</b> 868 MHz		<b>STANDARD JCM</b>

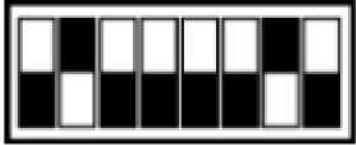
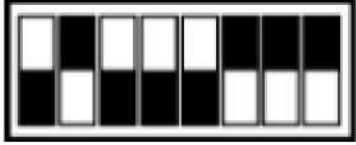
# MANUAL DE INSTALACION

5	<p>1 2 3 4 5 6 7 8</p> 	<p>Compatible con  <b>V2</b>  <b>868 MHz</b>  <b>433 MHz</b></p>		<p><b>SCAN MODE</b>          Remote scans BOTH V2 433 MHz and 868 Mhz.</p> <p><b>MODO SCAN</b>          El <u>mando</u> <u>escanea</u> <b>AMBOS modelos</b> de V2, 433 MHz y 868 Mhz.</p>
6	<p>1 2 3 4 5 6 7 8</p> 	<p>Compatible con  <b>Universal Fixed Code</b></p>		<p><b>SCAN MODE</b>          Remote scans ANY fixed code remote.</p> <p><b>MODO SCAN</b>          El <u>mando</u> <u>escanea</u> <b>CUALQUIER mando código fijo.</b></p>
7	<p>1 2 3 4 5 6 7 8</p> 	<p>Compatible con  <b>Universal Rolling Code</b></p>		<p><b>SCAN MODE</b>          Remote scans ANY rolling code remote.</p> <p><b>MODO SCAN</b>          El <u>mando</u> <u>escanea</u> <b>CUALQUIER mando rolling code.</b></p>